

# 8' Astra Display

## Product Parts

1. Bottom Right
2. Bottom Left
3. Top Right
4. Top Left
5. 8' Extension (x2)
6. Foot (x2)
7. Support Bars (x9)
8. Bottom A
9. Top A
10. Bottom C
11. Top C
12. Bottom B
13. Top B
14. Power Supply
15. Soft Case
16. Graphic (x2)

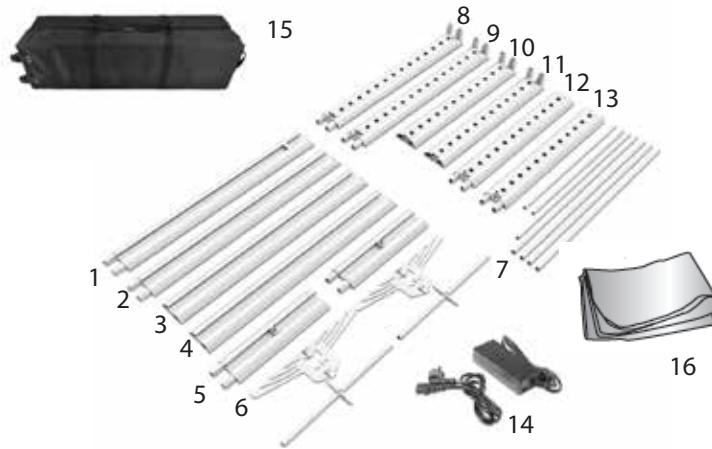

*Be Advised Pieces easily removable before graphic installation. If moving display after set-up hold from bottom section.*

*Symbols on hardware match corresponding pieces*

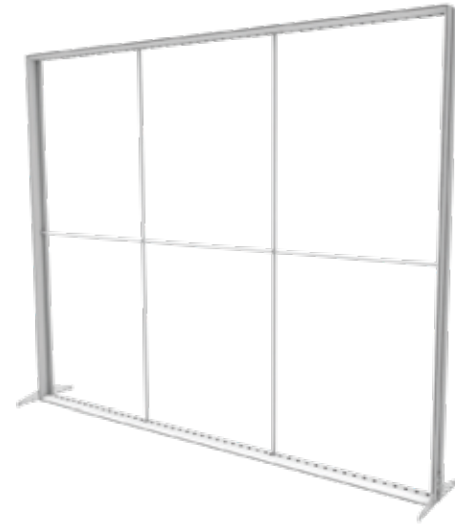

## Display Set-up

### Step 1

Connect Bottom A, B, and C sections (8, 10, 12) and place on floor.

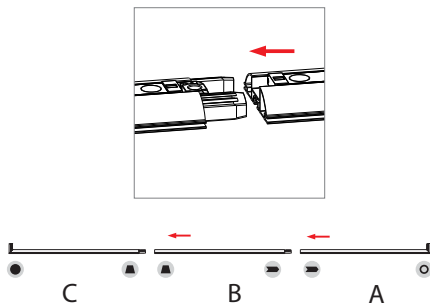

### Step 2

Connect Bottom Right(1) & Bottom Left (2) to Bottom A (8) and C (10).

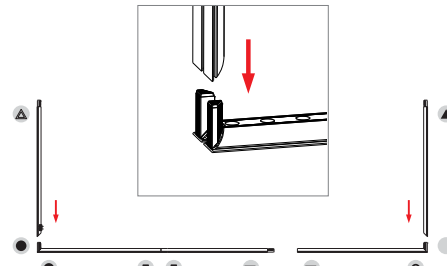

### Step 3

If using an 8' display attach 8 foot extensions (5) to Bottom Left & Right (1 & 2).

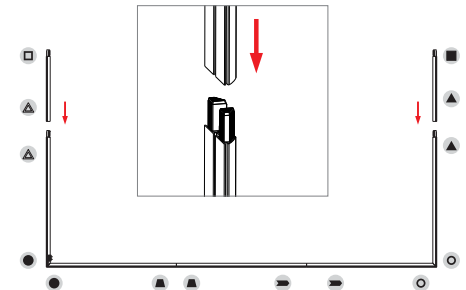

### Step 4

Attach the Support Bars (7) starting with the bottom bars and working upwards.

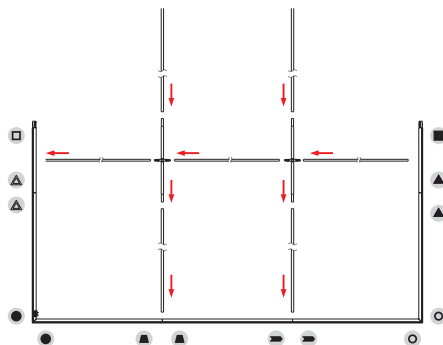
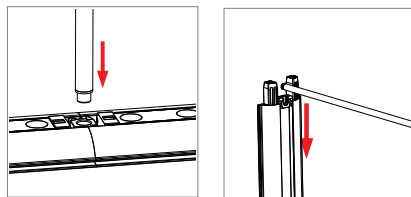

### Step 6

Gently lay down the display and attach Top Right (3) & Top Left (4) sections to left and right sections.

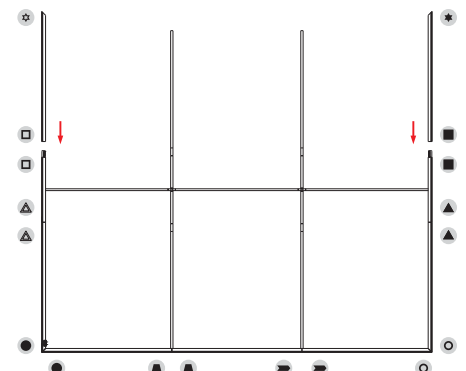
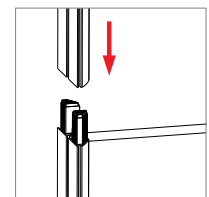

## Step 7

Connect Top A, B, and C pieces (9, 11, 13) and attach to Top Right (3) and Top Left (4) sections.

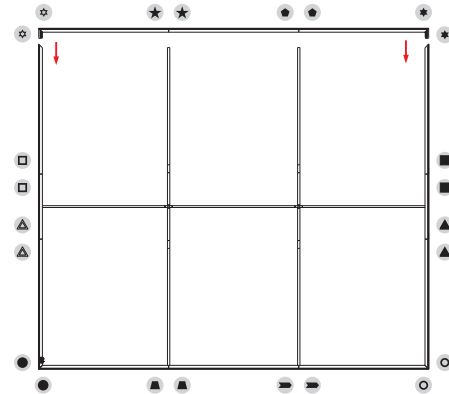
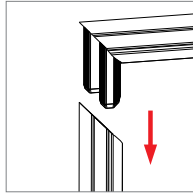

## Step 8

Stand the display up. Hold display to steady and carefully slide the Foot (6) knob into the groove on the display. Turn & press to lock.

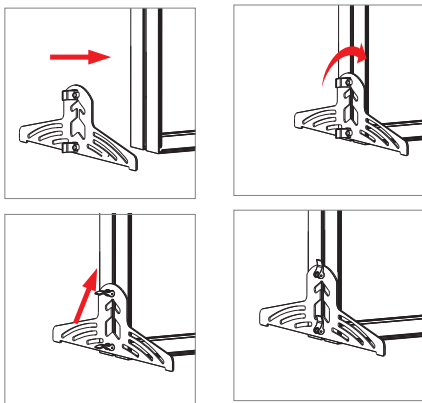

## Step 9

Plug the Power Supply (14) into the display. Plug in can be found near base next to left or right Foot..

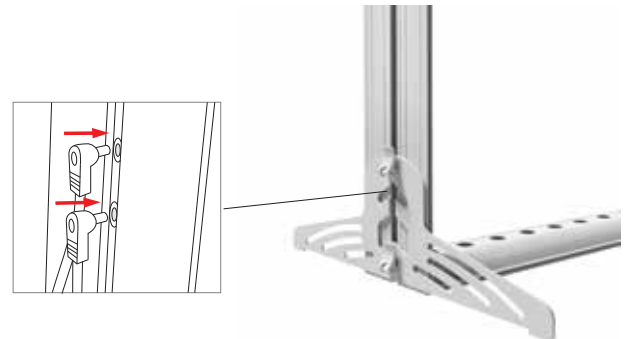

## Graphic Installation Process

### Step 1

Start with the corners. Working in a clockwise motion insert each corner of the graphic into the frame.

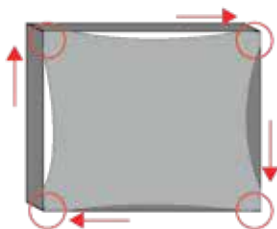

### Step 2

Move to the centers. Insert the centers of the graphic on each side of the frame.

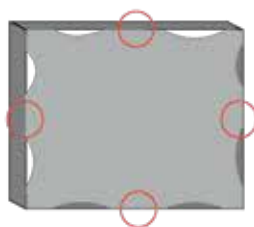

### Step 3

Complete installation. Insert the remaining portions of the graphic into the frame starting from the center points and working your way to the corners.

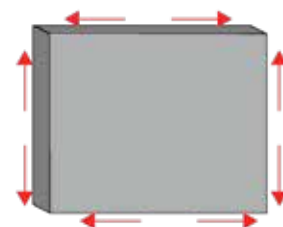

## Storage & Care

Place all product parts into Carry Case and store in a cool dry location. To clean non-graphic hardware, wipe with a damp cloth. Do NOT dry clean graphic, can Steam Clean wrinkles.