

Product Parts

- 1-Foot (x2)
- 2-Corner Piece (x4)
- 3-Straight Connector (x2)
- 4-Extrusion Bar (x6)

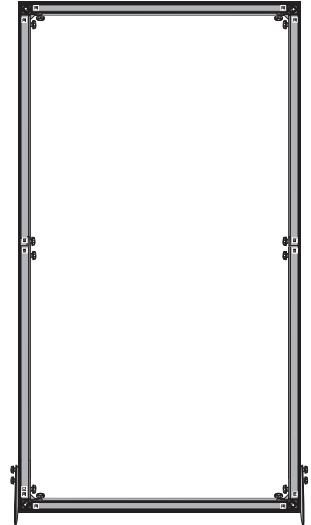
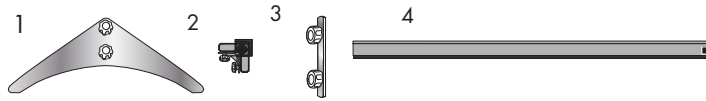

Display Set up

Step 1 (Overview of Frame Pieces)

Remove all of the product parts from the bag and place, on a clean flat surface. Take the time to review the pattern layout and notice that all pieces have one of the following symbols along with a number:



FOOT



RIGHT ANGLE



STRAIGHT

Make sure all labels are visible before you put your frame together. ALL LABELS MUST BE VISIBLE for frame to be assembled correctly.

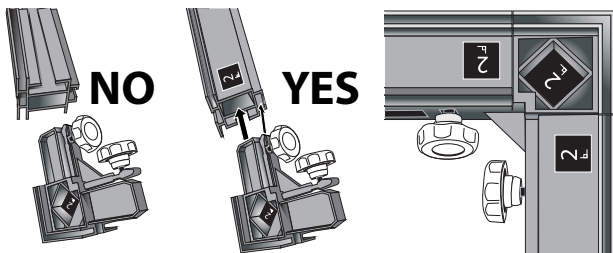

All Extrusion Bars (4) are connected using Straight Connectors (3)

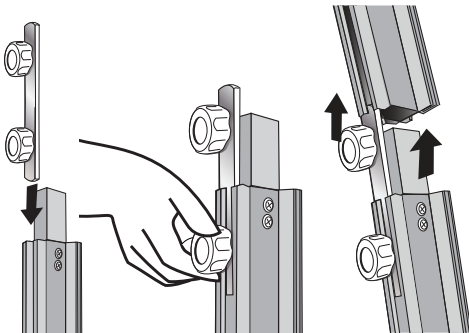

PATTERN LAYOUT:

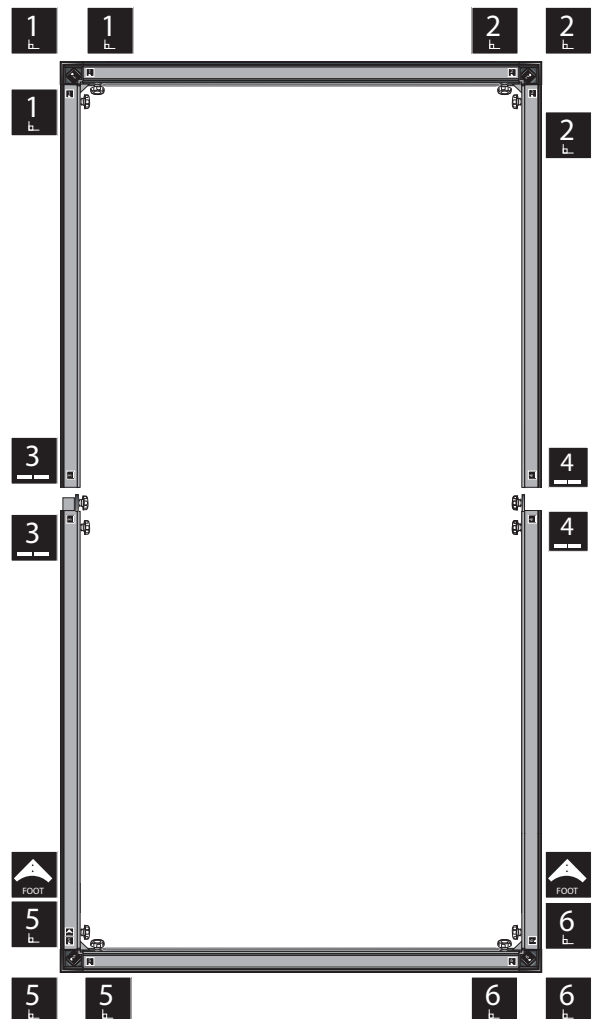

Display Set-Up

Step 2

Place the Foot (1) piece onto its corresponding Extrusion Bar BEFORE attaching bottom Corner Pieces (2). Make sure to slide the Foot (1) up enough on the bar to attach the Corner Piece (2)

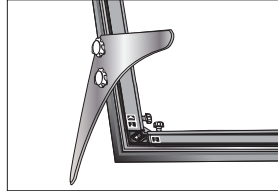
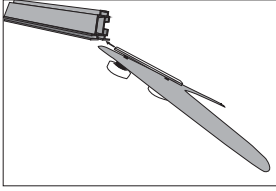

Step 3 Once the frame is all together set display upright. Lower the feet and tighten in place by turning both knobs.

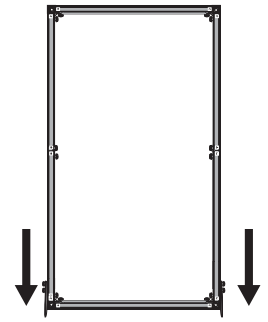
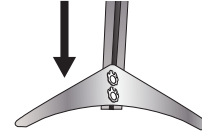

FRAME IS NOW READY FOR FABRIC GRAPHIC (sold separately).

Storage and Care

Place all product parts into Carry Case and store in a cool dry location.

To clean, wipe with damp cloth.